

29

Ophthalmology



DURRANI & CO





"a vision" not just a company

DURRANI & COMPANY



Lid Instruments
Instrumentes pour les paupières
Lidinstrumente

Tonometers
Tonomètres
Tonometer

Eye specula
Blépharostats
Lidsperrer

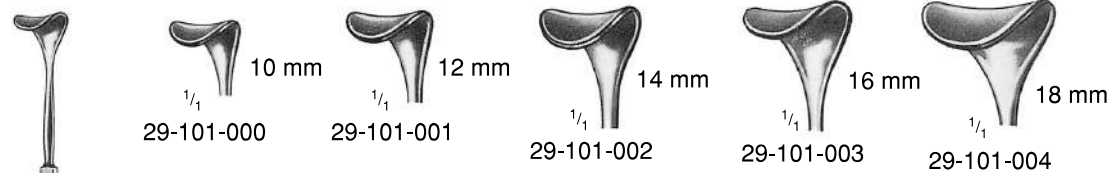

$\frac{1}{4}$ 10 mm
 29-101-000

$\frac{1}{4}$ 12 mm
 29-101-001

$\frac{1}{4}$ 14 mm
 29-101-002

$\frac{1}{4}$ 16 mm
 29-101-003

$\frac{1}{4}$ 18 mm
 29-101-004



$\frac{2}{3}$
Desmarres
 13 cm/5"

Lid Instruments
Instrumentes pour les paupières
Lidinstrumente



Graefe
 29-112-060 29-112-090
 6 cm/2 $\frac{1}{4}$ " 9 cm/3 $\frac{1}{2}$ "
 For children For Adults
 pour enfants pour adultes
 für kinder für kinder



Barraquer (Colibri)
 29-116-030 29-116-040
 For children For Adults
 pour enfants pour adultes
 für kinder für erwachsene



$\frac{1}{2}$
Castroviejo
 8 cm/3 $\frac{1}{4}$ "
 29-151-080



"a vision" not just a company

DURRANI & COMPANY



Various eye instruments Instruments oculaires divers Verschiedene augeninstrumente



$\frac{1}{4}$
29-200-120



$\frac{1}{4}$

29-201-120
Cataract needles
Aiguilles à cataracte
stamadein



$\frac{1}{4}$

Bowman
29-204-120
Discission needles
Aguilles à discission
Diszissionsnadein



$\frac{1}{4}$

Bowman
29-209-120



$\frac{1}{4}$

29-214-130
Foreign body needles
Aiguilles à corps étrsmgers
fremdkorpernadeln



$\frac{1}{4}$



$\frac{1}{4}$

Graefe
29-224-130



$\frac{1}{4}$

Graefe
29-225-130



$\frac{1}{4}$

Graefe
29-229-130

Cystotomes Kystitomes Cystotome



$\frac{2}{3}$

Kuhnt
29-234-001



$\frac{1}{4}$

Kuhnt
29-234-002



$\frac{1}{4}$

Kuhnt
29-234-003



$\frac{1}{4}$

Kuhnt
29-234-004

Corneal scarifiers Rugines pour la cornée Hornhautschaber

Lid plate plaque a pqpieres Lidplatte



$\frac{1}{2}$

Jaeger
11 cm/4 $\frac{1}{2}$ "
29-232-110



"a vision" not just a company

DURRANI & COMPANY



Delicate eye hooks
Crochets oculaires
Aggenhäkchen

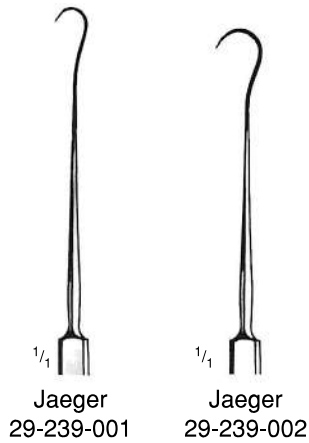

Lens expressors
Crochets pour extraction du cristallin
Linsenexpressoren

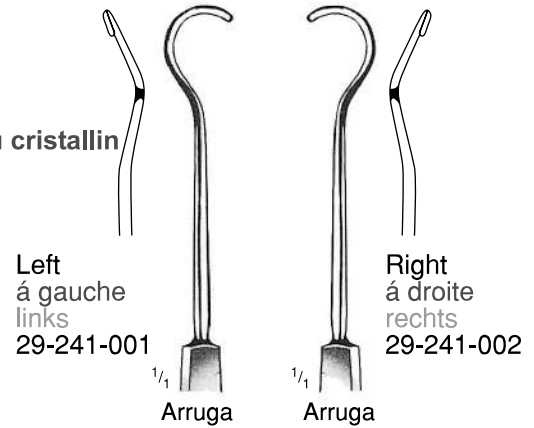

Delictae eye hooks
Crochets oculaires
Augenhäkchen

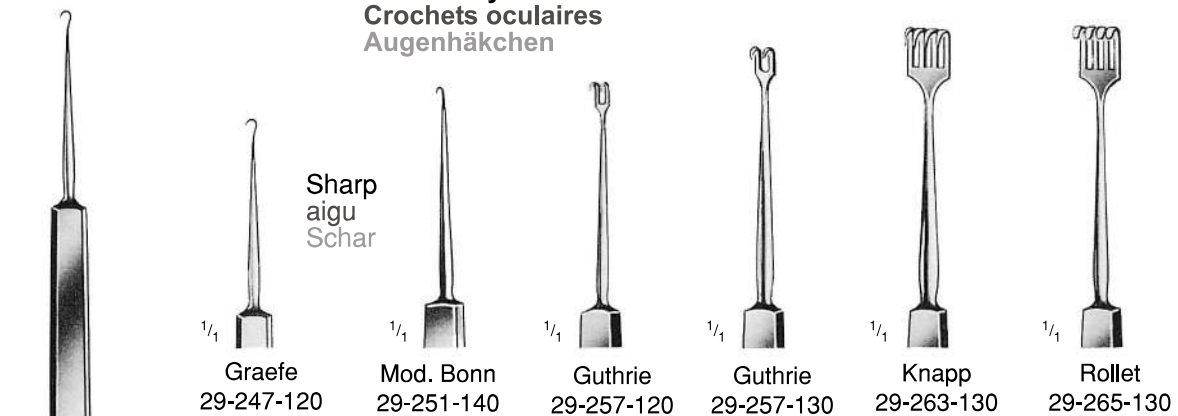

Strabismus hooks
Crochets à strabisme
Schielhaken

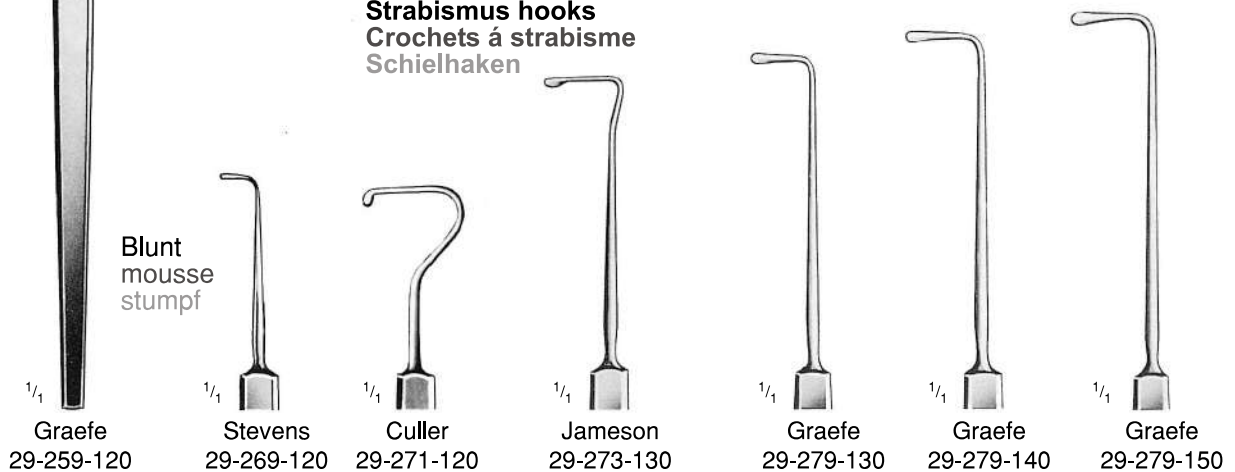



"a vision" not just a company

DURRANI & COMPANY



Various eye instruments
Instruments oculaires
Verschiedene augeninstrumente

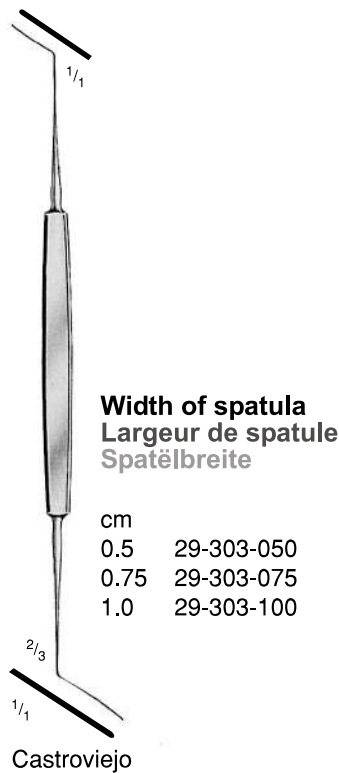
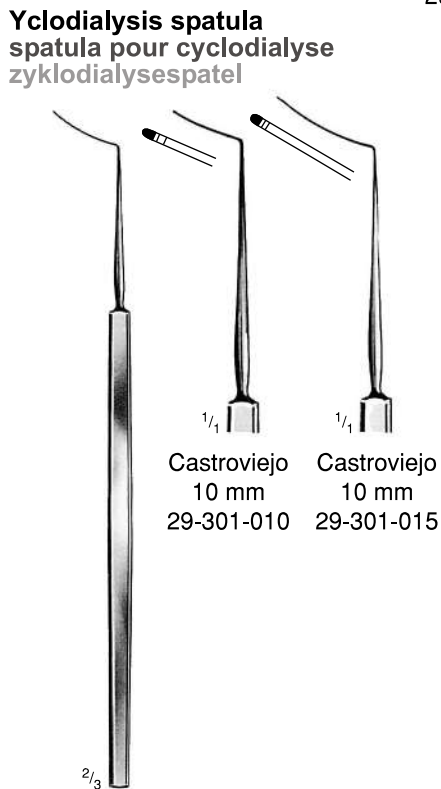
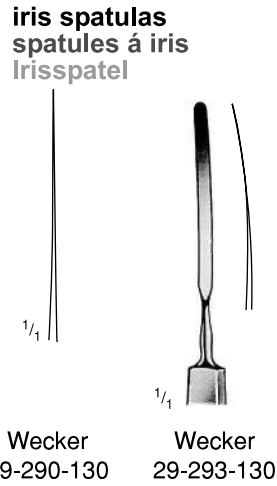
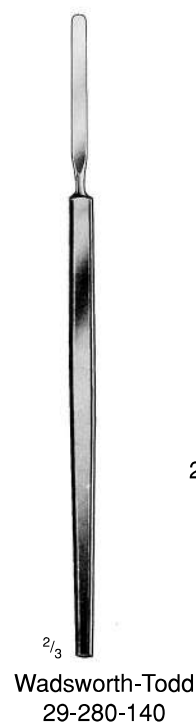



"a vision" not just a company

DURRANI & COMPANY



Various eye instruments
Instruments oculaires
Verschiedene augeninstrumente



Air cannulas
canules a air
Luftkanulen

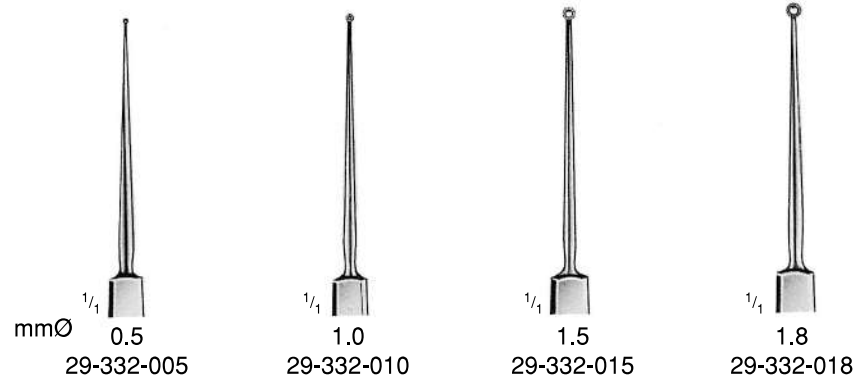

chalazion curettes
Curettes á chalazion
Chalazionslöffel

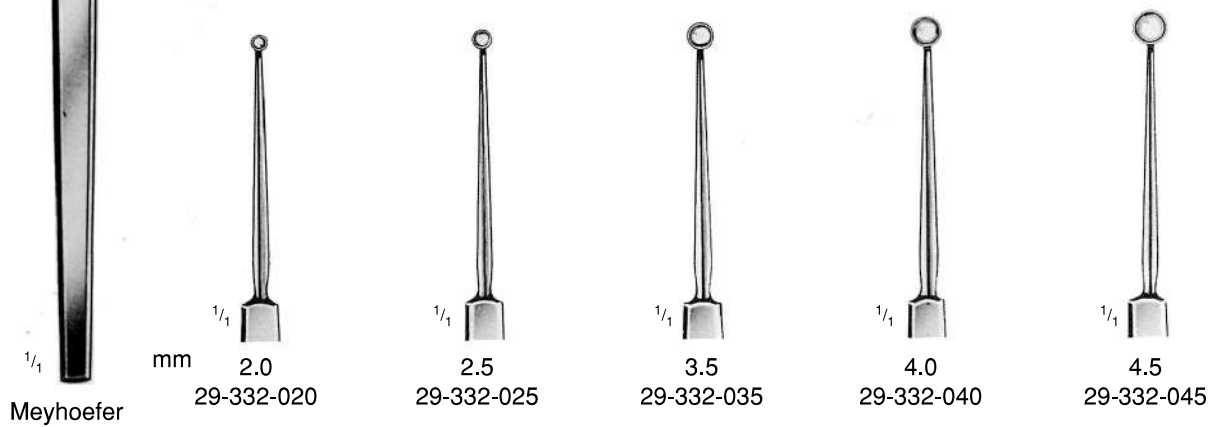



"a vision" not just a company

DURRANI & COMPANY



Various eye instruments
Instruments oculaires
Verschiedene augeninstrumente

Lachrymal dilators
Dilateurs pour les voies lacrymales
Tränenkanaldilatatoren



²/₃
Wilder
 29-340-001



²/₃
Wilder
 29-340-002



²/₃
Wilder
 29-340-003

Lachrymal Sac Chisel
ciseaux-burins pour le sac lacrymal
Tränensackmeißel



¹/₂
West
 29-350-160

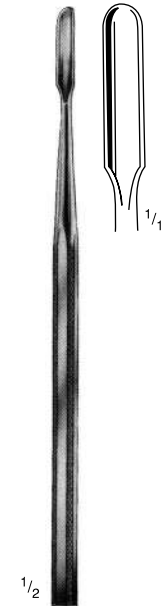

¹/₂
West
 29-360-160

Lachrymal Probe
Stylets pour les voies lacrymales
Tränenkanalsonden



Fig.
 00/0 29-380-000
 0/1 29-380-001
 1/2 29-380-012
 2/3 29-380-023
 3/4 29-380-034
 4/5 29-380-045
 5/6 29-380-056
 6/7 29-380-067
 7/8 29-380-078

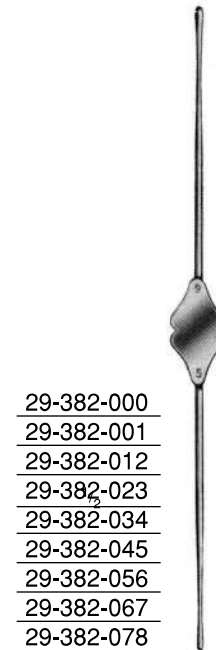

29-382-000
 29-382-001
 29-382-012
 29-382-023
 29-382-034
 29-382-045
 29-382-056
 29-382-067
 29-382-078

Fig.	00	0	1	2	3	4	5	6	7	8
mmø	0.7	0.8	0.9	1.1	1.3	1.4	1.5	1.6	1.8	1.9



"a vision" not just a company

DURRANI & COMPANY



Various eye instruments
Instruments oculaires
Verschiedene augeninstrumente



Scieral caliper
Compas á marquer
Markierungszirkel

Castroviejo
 29-390-020



$\frac{1}{4}$
Alvis
 29-394-120



$\frac{1}{4}$
Ellis
 29-397-110

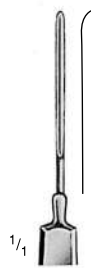

$\frac{1}{4}$
Meyer
 29-400-120

Foreign body instruments
instruments pour corps étrangers
Fremdkörperinstrumente



$\frac{2}{3}$ $\frac{1}{4}$
 29-402-130

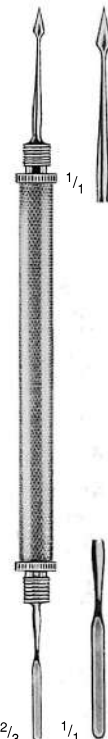

$\frac{2}{3}$ $\frac{1}{4}$
 29-404-130



"a vision" not just a company

DURRANI & COMPANY



Various eye instruments

Instruments oculaires

Verschiedene augeninstrumente

Foreign body loop and eye magnet

Anse pour corps étrangers et aim ant oculaire

Fremdkörperschlinge und Augenmagnet



$\frac{1}{2}$
Standard
29-410-000

Razor blade breakers
Pinces brise-lames de rasoir
Rasierklingen dreher



$\frac{2}{3}$
Troutman-Chris
5.5 mm \emptyset
9 cm/ $3\frac{1}{4}$ "
29-420-090

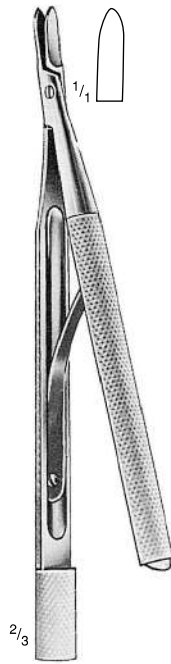

$\frac{2}{3}$
Castroviejo
13 cm/5"
mm \emptyset
8 29-430-130
10 29-430-130



6 mm \emptyset
cm inch.
9 $3\frac{1}{2}$ 29-440-090
12 $4\frac{3}{4}$ 29-440-120

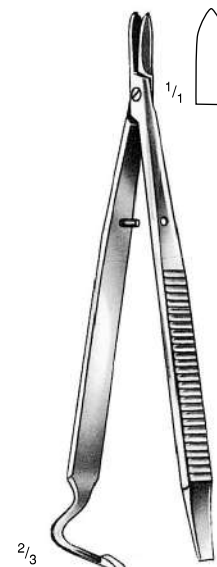

$\frac{2}{3}$
11 cm/ $4\frac{1}{2}$ "
29-452-110

32

Otology



DURRANI & CO





"a vision" not just a company

DURRANI & COMPANY



Ear specula Spéculums auriculaires ohrspekula

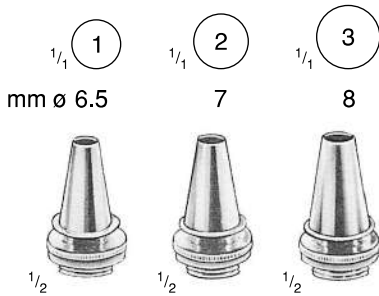

Complete with 3 ear specula and rubbe with bulb
complète avec 3 spéculums auriculaires et soufflerie
komplett mit spekula und gebläse

For sucklings
pour nourissons
für säuglinge



Troeltsch
32-104-003

Set of 3 pieces
jeu de 3 pièces
satz zu 3 stück

For adults
pour adultes
für erwachsens

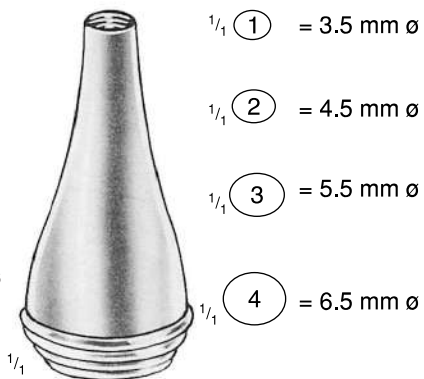

Gruber

Set of jeu de satz zu	pieces pieces stück	Fig. fig. fig.	
3	2-4	32-112-003	
4	1-4	32-112-004	

For adults
pour adultes
für erwachsens

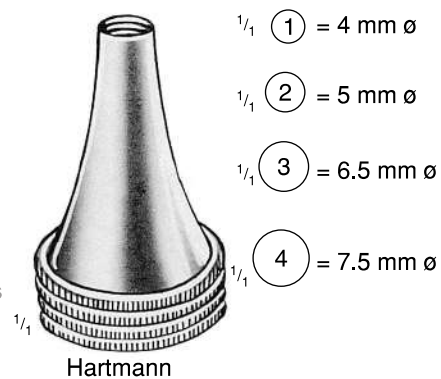

Hartmann

Set of jeu de satz zu	pieces pieces stück	Fig. fig. fig.	
3	2-4	32-116-003	
4	1-4	32-116-004	



"a vision" not just a company

DURRANI & COMPANY



**Tuning Forks
Diapasons
Stimmgabeln**

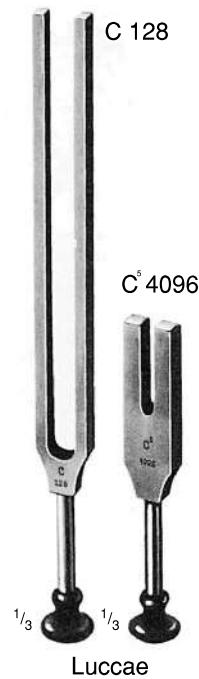

Luccae

c	128	32-132-001
c ¹	256	32-132-002
c ²	512	32-132-003
c ³	1024	32-132-004
c ⁴	2048	32-132-005
c ⁵	4096	32-132-006

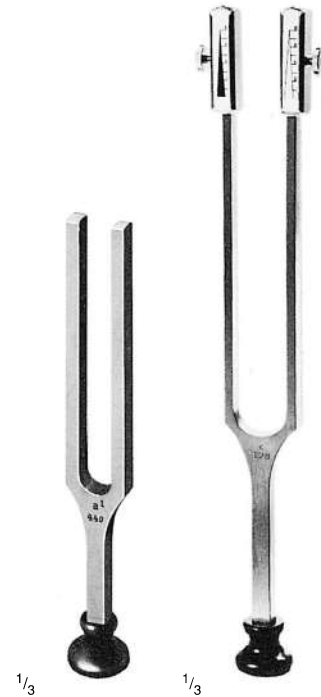

32-142-000

Rydel-Seiffer
32-146-000

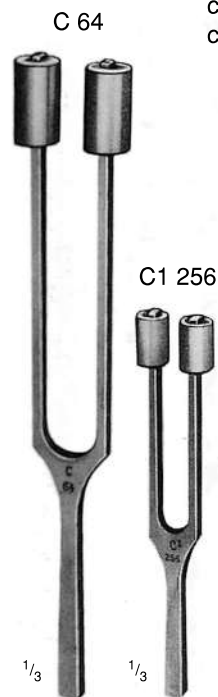

French

c ²	16	32-152-001
c ¹	32	32-152-002
Hartmann		
c	64	32-156-001
c	128	32-156-002
c ¹	256	32-156-003

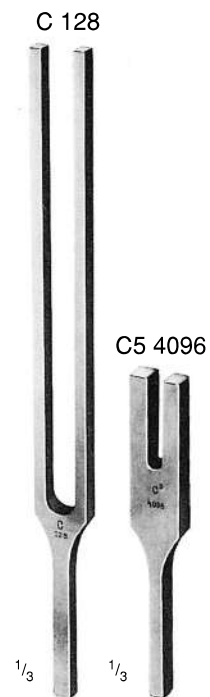

Hartmann

c	128	32-162-001
c ¹	256	32-162-002
c ²	512	32-162-003
c ³	1024	32-162-004
c ⁴	2048	32-162-005
c ⁵	4096	32-162-006



"a vision" not just a company

DURRANI & COMPANY



Tuning Forks Diapasons Stimmgabeln

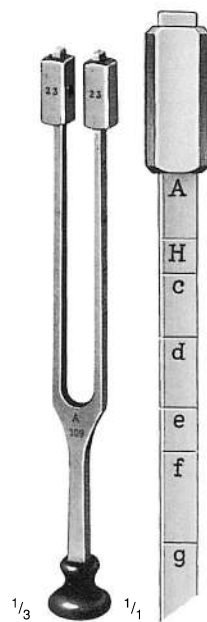

A 109
Koenig
32-182-000

Variable upto g (engl.B)
Variable jusqu'à g (en franc. sol)
Verschiebbar bis g

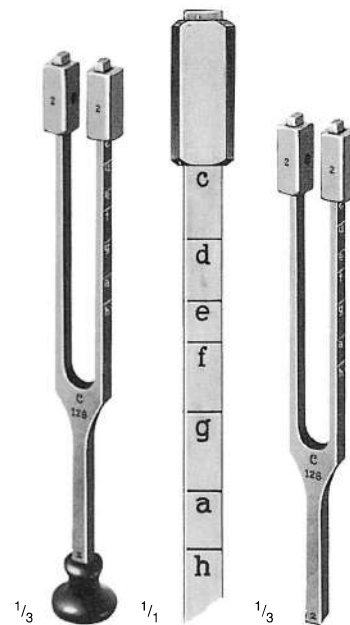

C128
Lucae
32-192-000

C 128
Hartmann
32-196-000

Variable upto h (engl.B)
Variable jusqu'à h (en franc. sol)
Verschiebbar bis h



"a vision" not just a company

DURRANI & COMPANY



Ear Syringes
Seringues auriculaires
Ohrspritzen

Ear polypus Snares
Serre-noeuds auriculaires
Ohrpolypenschnürer

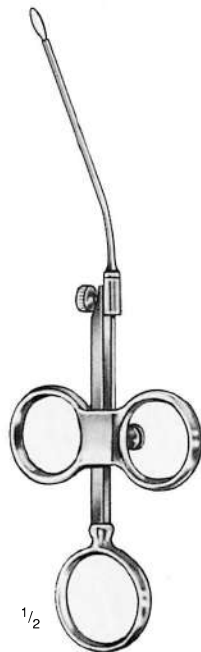

¹/₂
Krause
16 cm/6¹/₄"
32-201-160



¹/₂
Lange-Wilde
16 cm/6¹/₄"
32-205-160

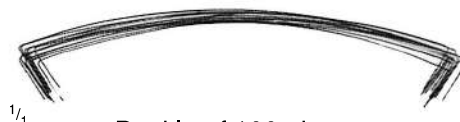

¹/₄
Bunkle of 100 pieces
botte de 100 pièces
bündel zu 100 Stück
mm ø
0.2 32-211-002
0.3 32-211-003



¹/₄



¹/₄



¹/₄

50 ml 32-222-050
75 ml 32-222-075
100 ml 32-222-100

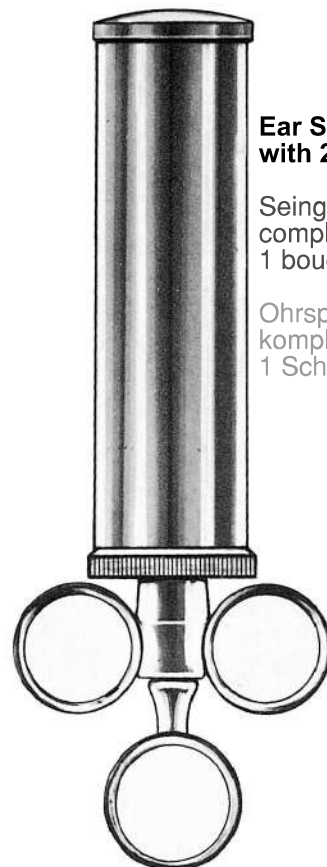

**Ear Syringe, complete
with 2 tips and 1 shield**

Seingue auriculaire,
complète avec 2 embouts et
1 bouclier protecteur

Ohrspritze,
komplett mit 2 kanülen und
1 Schutzteller



"a vision" not just a company

DURRANI & COMPANY



Ear Polypus Forceps
Pinces à polypes auriculaires
Ohroplypenzangen

Foreign Body Lever
levier pour corps étrangers
Fremdkörperhebel

Ear Polypus Forceps
Pinces à polypes auriculaires
Ohroplypenzangen

Length of Shaft
longueur de la tige
Schaftlänge

Cm	Inch	Hartmann-Wullstein	Hartmann	Hartmann
8.5 cm	3 1/2"	32-232-085	32-236-085	32-238-085
14	5 1/2"		32-236-140	32-238-140

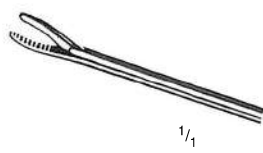
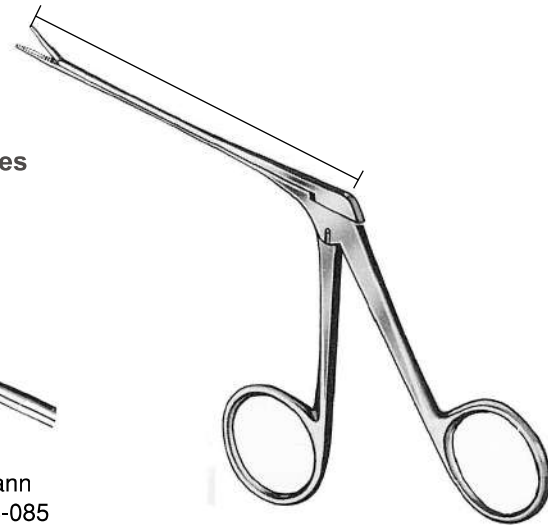

Hartmann-Weingartner
8.5 cm / 3 1/2"
32-240-085



Hartmann-Wullstein
8.5 cm / 3 1/2"
32-244-085



Struempel
8.5 cm / 3 1/2"
32-248-085



Hartmann
8.5 cm / 3 1/2"
32-252-085

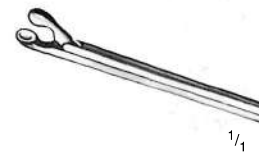

Hartmann
8.5 cm / 3 1/2"

- 2 mm ø
- 2.5 mm ø
- 3 mm ø

Cm	Inch	mmø	
8.5 cm	3 1/2"	2	32-260-020
8.5 cm	3 1/2"	2.5	32-260-025
8.5 cm	3 1/2"	3	32-260-030

Foreign Body Lever
Levier pour corps étrangers
Fremdkörperhebel

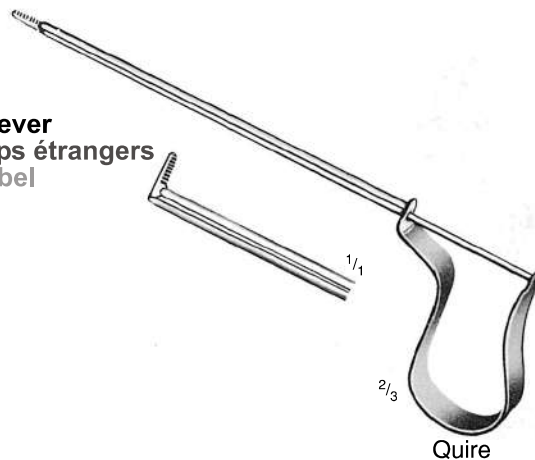

Quire
32-272-100



"a vision" not just a company

DURRANI & COMPANY



Micro Ear Scissors Microciseaux auriculaires Micro-Ohrscheren

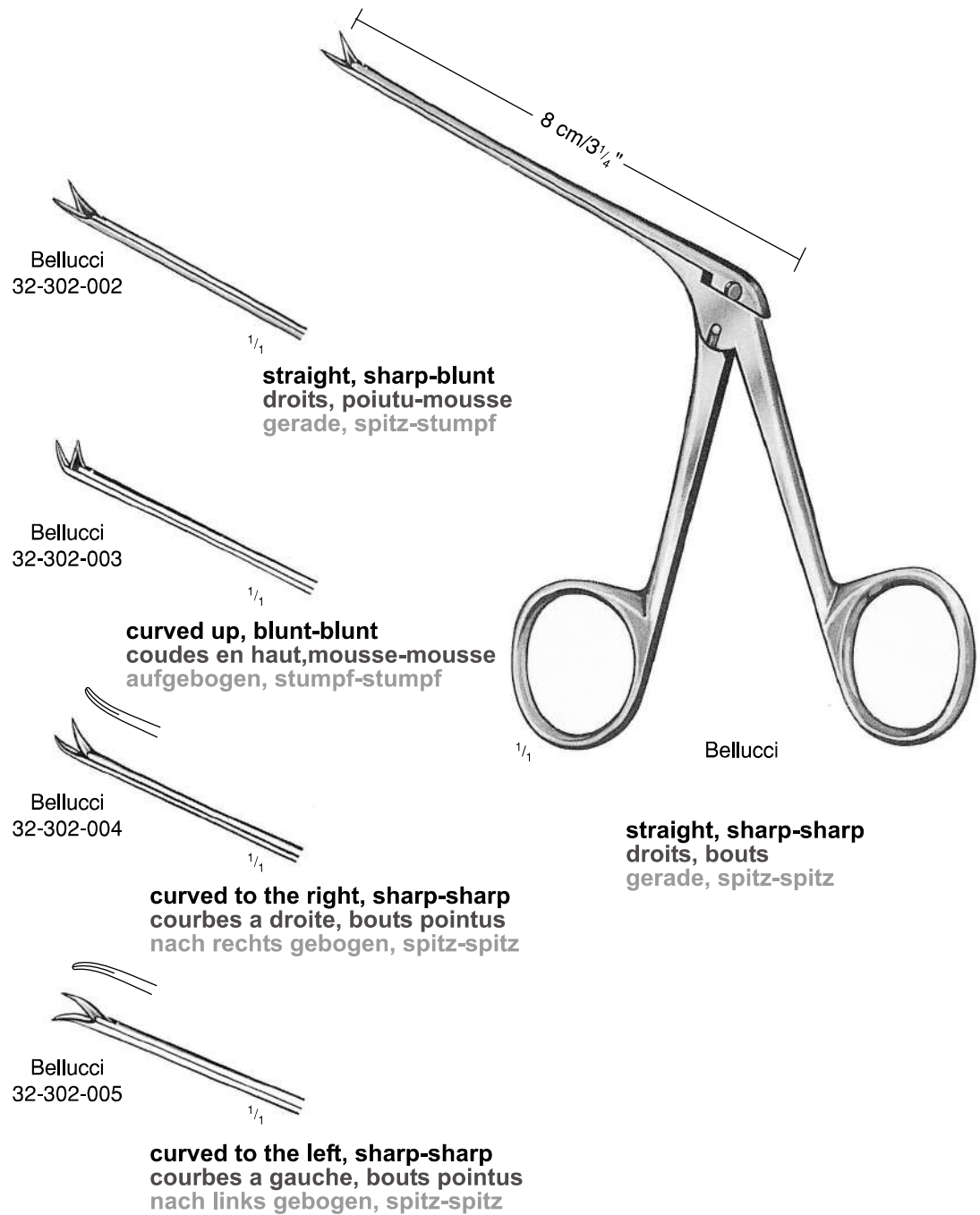



"a vision" not just a company
DURRANI & COMPANY



Ear Currettes Currettes auriculaires Ohrküretten

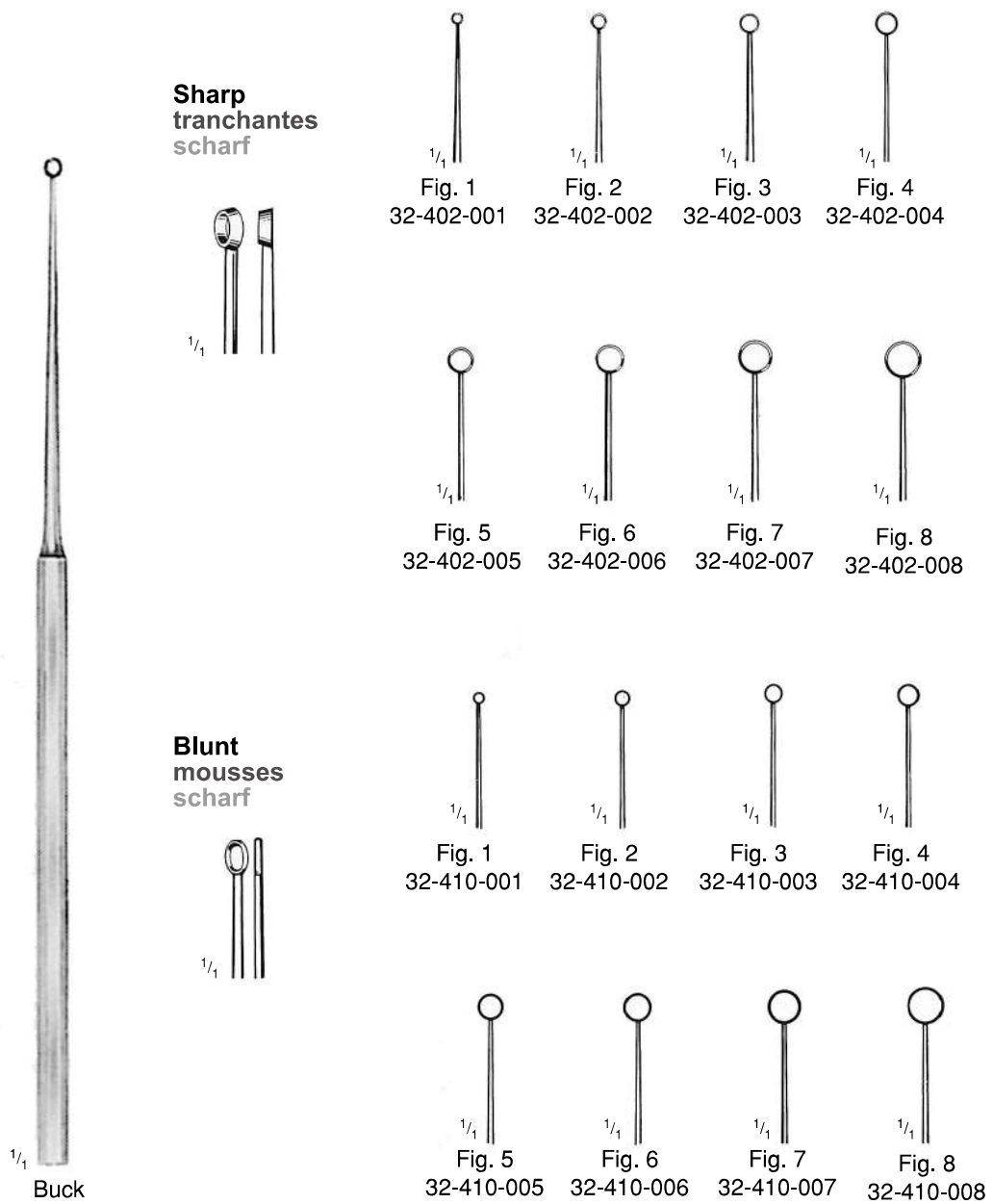



"a vision" not just a company

DURRANI & COMPANY



Ear Currettes
Curettes auriculaires
Ohrküretten

Sharp
tranchantes
scharf

Blunt
mousses
scharf

Fig. 1
 32-421-001

Fig. 2
 32-421-002

Fig. 3
 32-421-003

Fig. 4
 32-421-004

Fig. 5
 32-421-005

Fig. 6
 32-421-006

Fig. 7
 32-421-007

Fig. 8
 32-421-008

Fig. 1
 32-431-001

Fig. 2
 32-431-002

Fig. 3
 32-431-003

Fig. 4
 32-431-004

Fig. 5
 32-431-005

Fig. 6
 32-431-006

Fig. 7
 32-431-007

Fig. 8
 32-431-008



"a vision" not just a company

DURRANI & COMPANY



Double-end Ear Instruments Instruments Auriculaires Doubles Ohrdoppelinstrumente

Ear Loops Anses Auriculaires Ohrschlingen

Ear Loops Anses Auriculaires Ohrschlingen

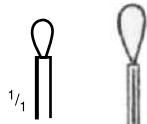

32-452-001



32-452-002



32-452-003



Billeau
16.5 cm/6 $\frac{1}{2}$

Double-end Ear Instruments Instruments Auriculaires Doubles Ohrdoppelinstrumente

Blunt mousses Stumpf



$\frac{1}{4}$
Gross
12 cm/4 $\frac{3}{4}$
32-262-120

Blunt-Sharp Mousse-Tranchante Stumpf-Scharf



$\frac{1}{4}$ $\frac{1}{4}$
Gross
12 cm/4 $\frac{3}{4}$
32-268-120

36

Rhinology



DURRANI & CO





"a vision" not just a company
DURRANI & COMPANY



Nasal Specula
speculums nasaux
Nasenspekula



Mod. Wien (Vienna pattern)
 14 cm/5 1/2"

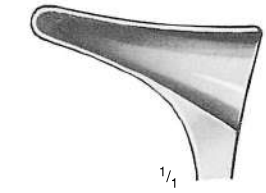

36-011-001

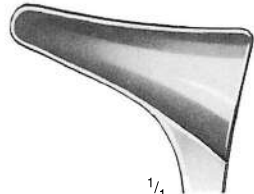

36-011-002

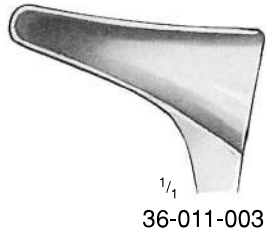

36-011-003



Killian
 13 cm/5"

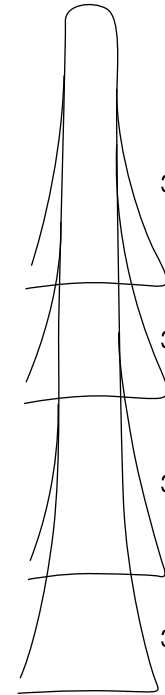

35 mm
 36-017-001

50 mm
 36-017-002

75 mm
 36-017-003

90 mm
 36-017-004



Hartmann
 16.5 cm/6 1/2"

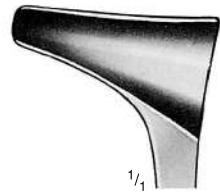

36-019-001

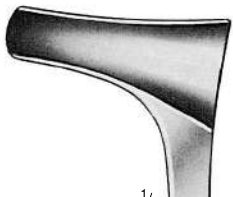

36-019-002

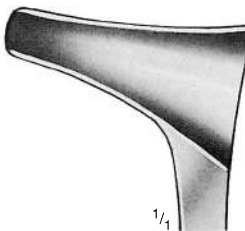

36-019-003



Hartmann-Halle
 15 cm/6"



36-023-001

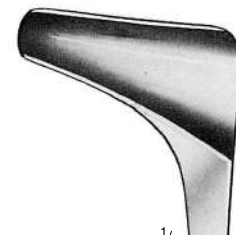

36-023-002



36-023-003



"a vision" not just a company
DURRANI & COMPANY



Nasal Specula
 spéculums nasaux
 Nasenspekula

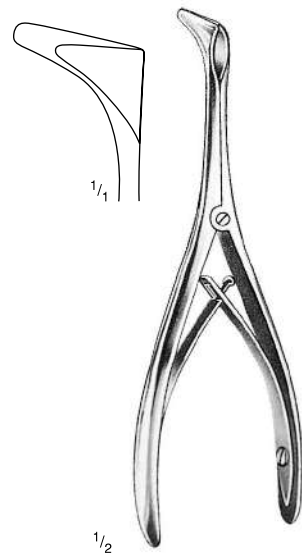

Tieck-Halle
 13.5 cm/5 1/4"
 36-031-000

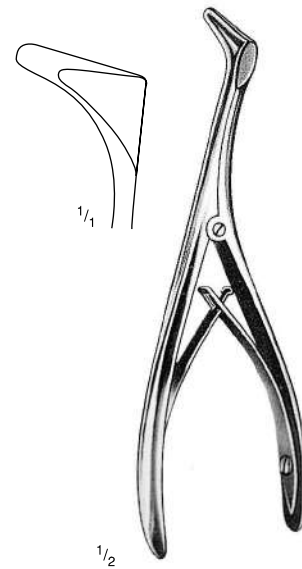

Tieck-Halle
 13.5 cm/5 1/4"
 36-033-000

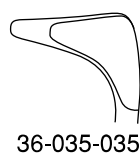

36-035-035

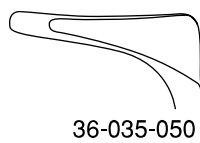

36-035-050

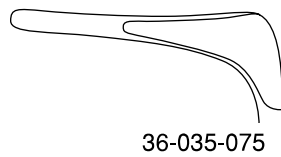

36-035-075

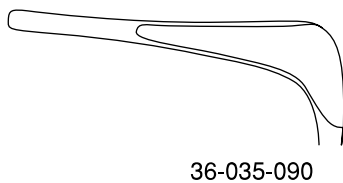

36-035-090



Cottle
 14 cm/5 1/2"



36-040-001

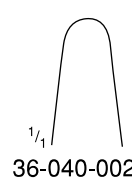

36-040-002

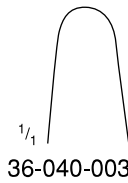

36-040-003

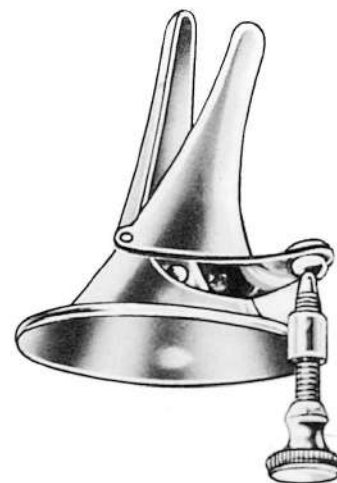

Voltolini



"a vision" not just a company

DURRANI & COMPANY



Nasal Specula Serre-noeuds nasaux Nasenpolypenschnürer

Snare wires, preshaped
anses pour serre-noeuds, preformées
Nasenpolypenschnürer



0.3 mm \varnothing
36-043-003
in bundles of 100 pieces
en bottes de 100 pièces
in Bündeln zu 100 Stück

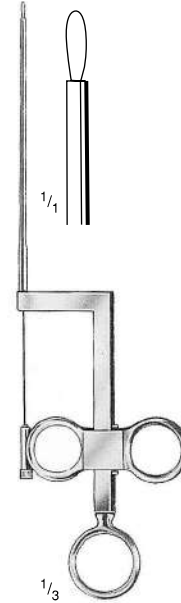

Lange-Wilde
24 cm/9 1/2"
36-045-240

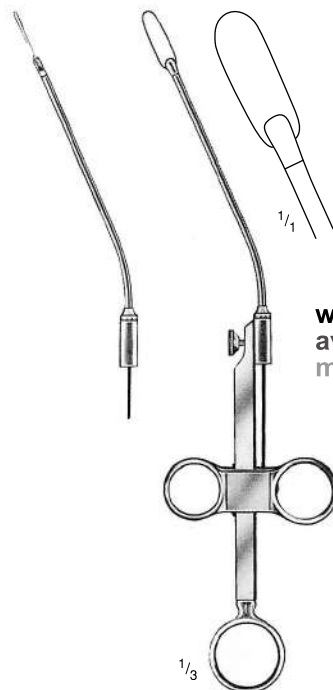

with 2 cannulas
avec 2 guide-anses
mit 2 Aufsätzen

Krause-Voss
26 cm/10 1/4"
36-049-260

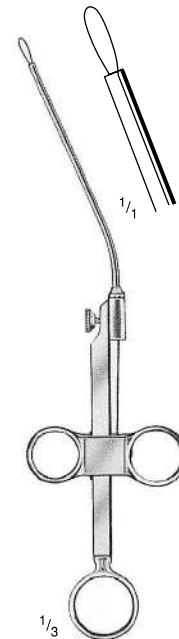

Krause
26 cm/10 1/4"
36-053-260



"a vision" not just a company

DURRANI & COMPANY



Nasal Specula
Pince á nasaux
Nasen zangen

without neck
Sanscol
ohne hals



with neck
avec col
mit Hals



Nasal cutting forceps
pincas coupantes pour le ne
scharfee nasenzangen

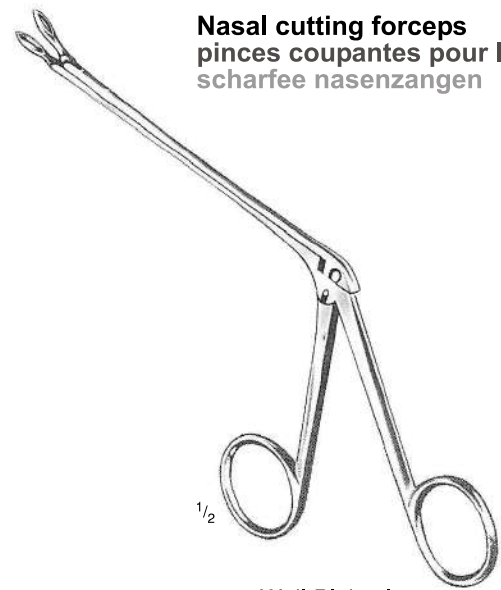

Weil-Blakesley
 19 cm/7 1/2"



Bruenings
 19 cm/7 1/2"

Nasal polypus forceps
pince á polypues nasaux
nasenpolypenzange

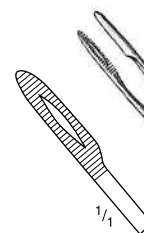

Septum forceps
pincas pour la cloison nasale
septumzangen

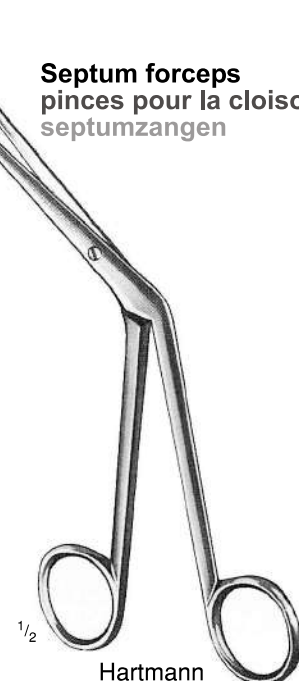

Hartmann
 20 cm/8"
 36-077-200



"a vision" not just a company

DURRANI & COMPANY



Nasal Cutting Forceps Pince coupantes pour le nez Scharfe Nasenzangen

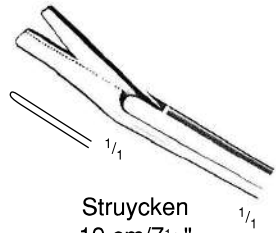

Struycken
19 cm/7 1/2"
36-101-001

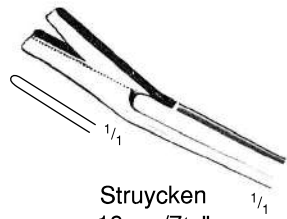

Struycken
19 cm/7 1/2"
36-101-002

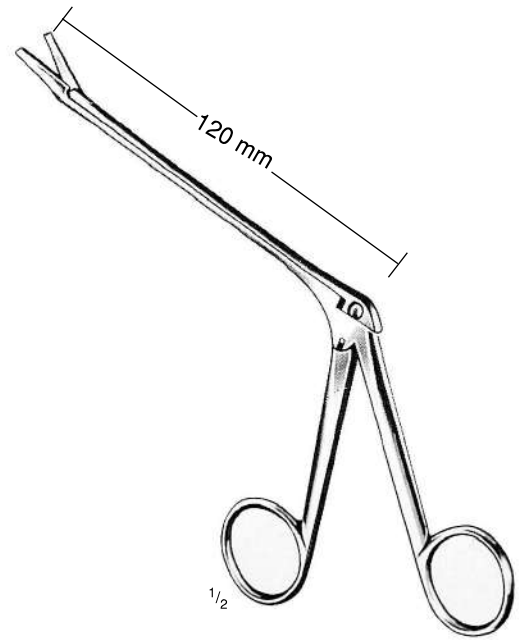

5 mm ø
36-107-005



7 mm ø
36-107-007



9 mm ø
36-107-009



11 mm ø
36-107-011



Hartmann
19 cm/7 1/2"

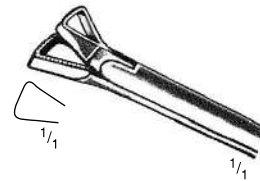

Schmeden
19 cm/7 1/2"
36-109-120

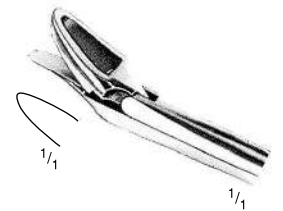

Tomati
19 cm/7 1/2"
36-111-120



"a vision" not just a company

DURRANI & COMPANY



Nasal Cutting Forceps
Pince coupantes pour le nez
Scharfe Nasenzangen

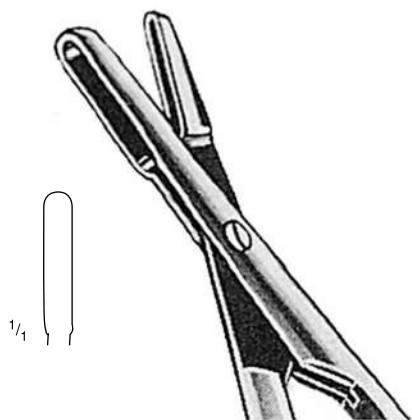

Middleton-jansen
19 cm/7 1/2"
36-141-190

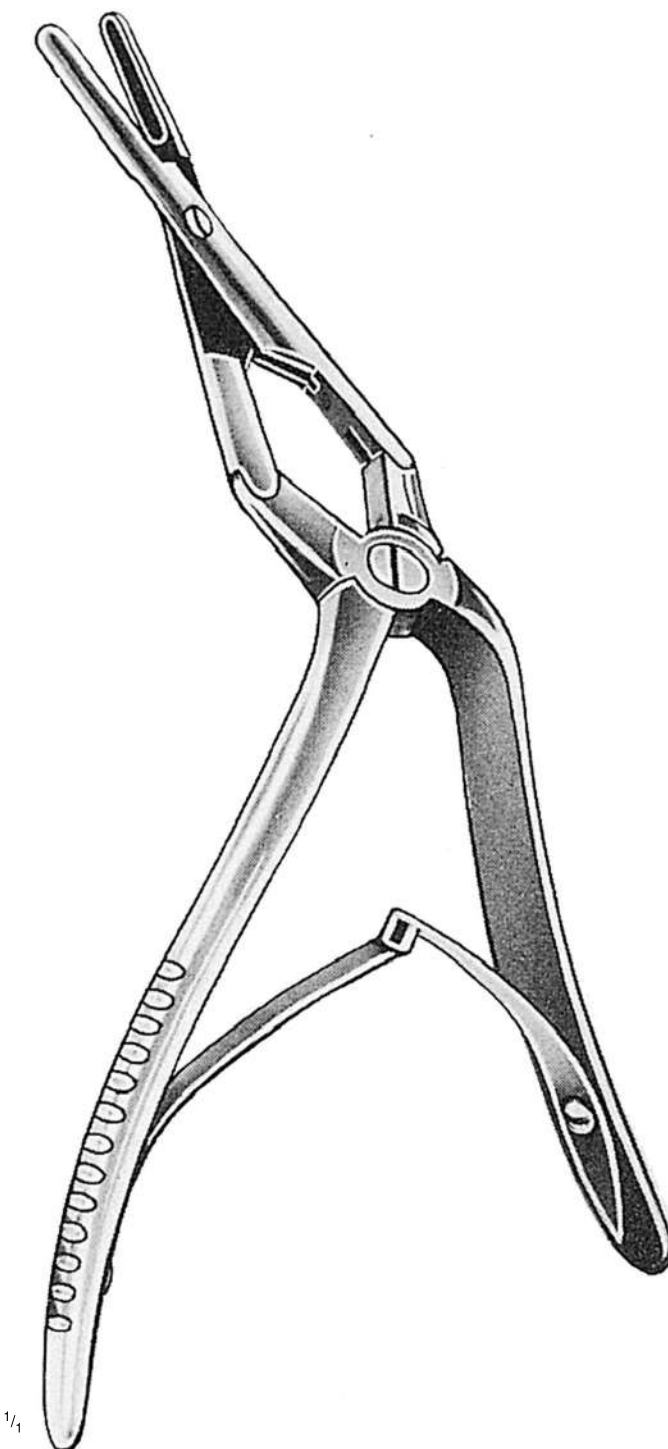
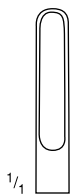

Middleton-jansen
19 cm/7 1/2"
36-147-190



"a vision" not just a company
DURRANI & COMPANY



Septum Straighteners
Pince pour redresser la cloison nasale
Septumrichtzangen

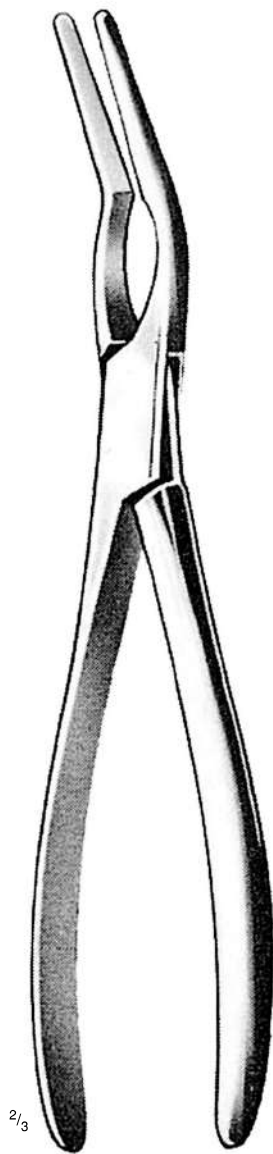

$\frac{2}{3}$

Asch
23 cm/9"
36-151-230

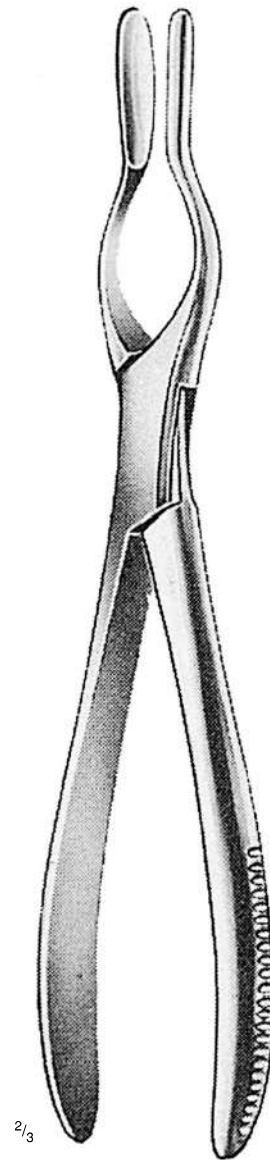

$\frac{2}{3}$

Cottle-Walsham
23 cm/9"

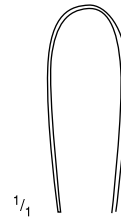

$\frac{1}{4}$

36-156-001



$\frac{1}{2}$

36-156-001



$\frac{1}{4}$

36-156-001



"a vision" not just a company

DURRANI & COMPANY



Chisels and Gouges
Ciseaux-burins et Gouges
Flach-und Hohlmeißel

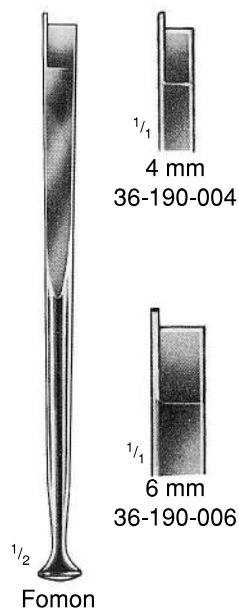
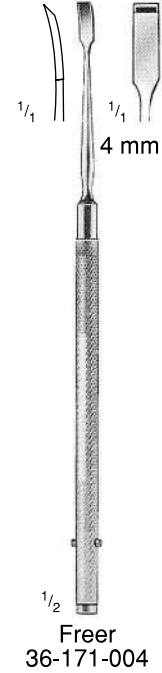
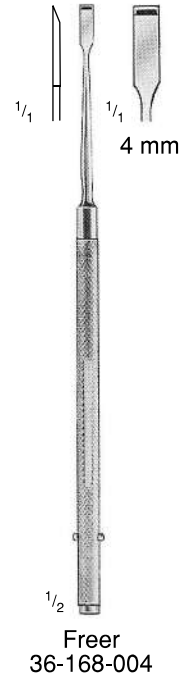
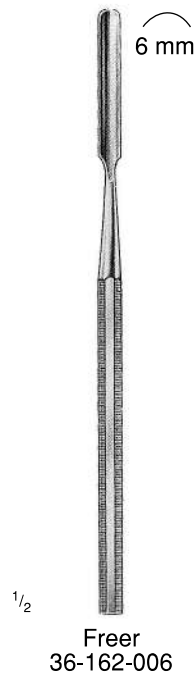

Cottle
 7 mm 36-180-007
 12 mm 36-180-012



Cottle
 4 mm 36-184-004



Cottle
 6 mm 36-187-006



"a vision" not just a company

DURRANI & COMPANY



Nasal Rasps
Râpes nasales
Nasenrespeln

Nasal Saws
Scies Nasales
Nasensägen

Nasal Rasps
Scies Nasales
Nasensagen

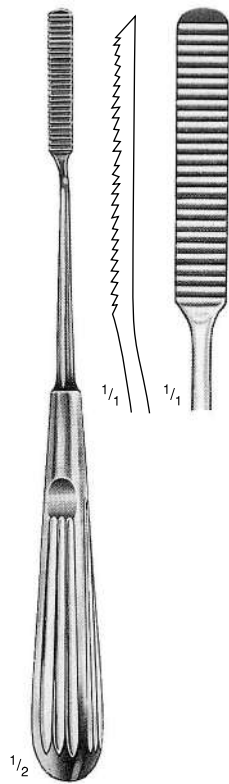

Cottle
21 cm/8 1/4"
36-202-000

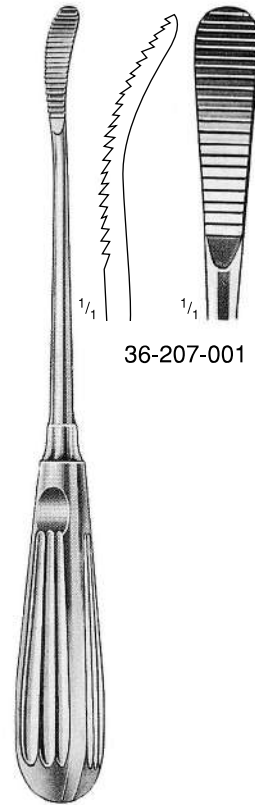

Aufricht
21 cm/8 1/4"

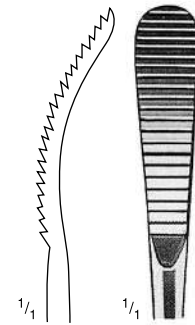

36-207-002

36-207-001

Nasal Rasps
Râpes nasales
Nasenraspein



Joseph
36-212-000



Joseph
36-219-001



Joseph
36-219-002



Joseph
36-241-001 36-241-002



"a vision" not just a company

DURRANI & COMPANY



Double-end Curette, Adenoid Currettes
Curette double, Couteaux pour végétations adénoïdes
Doppelkürette, Ringmesser



$\frac{1}{2}$
 Beckmann
 22 cm/8 $\frac{3}{4}$ "

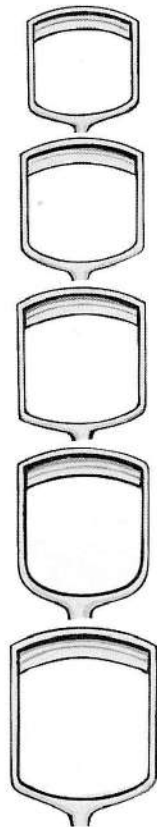

$\frac{1}{4}$

- 36-291-001
- 36-291-002
- 36-291-003
- 36-291-004
- 36-291-005



$\frac{1}{2}$
 St. Clair-Thomson
 21 cm/8 $\frac{1}{4}$ "

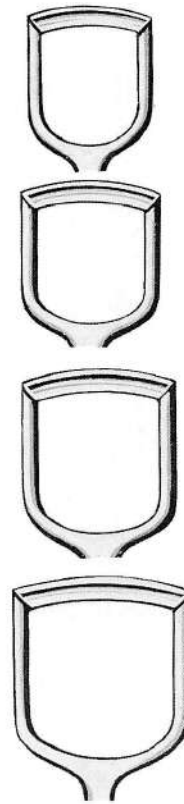

$\frac{1}{4}$

- 36-297-001
- 36-297-002
- 36-297-003
- 36-297-004

Double-end Curette
Curette double
Doppelkürette

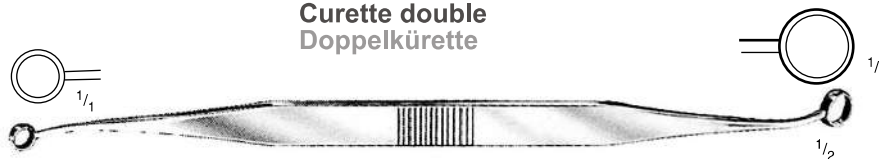

Falkner
 21 cm/8 $\frac{1}{4}$ "
 36-299-210

$\frac{1}{4}$

$\frac{1}{4}$

$\frac{1}{2}$